

GA-970A-DS3P

User's Manual

Rev. 1001

12ME-970AS3P-1001R

Declaration of Conformity

We, Manufacturer/Importer,

G.B.T. Technology Trading GmbH

Address: **Bullenkoppel 16, 22047 Hamburg, Germany**

Declare that the product

Product Type: **Motherboard**

Product Name: **GA-970A-DS3P**

conforms with the essential requirements of the following directives:

2004/108/EC EMC Directive:

- | | |
|--|------------------------------|
| <input checked="" type="checkbox"/> Conduction & Radiated Emissions: | EN55022:2006+A1:2007 |
| <input checked="" type="checkbox"/> Immunity: | EN55024:1998+A1:2001+A2:2003 |
| <input checked="" type="checkbox"/> Power-line harmonics: | EN61000-3-2:2006 |
| <input checked="" type="checkbox"/> Power-line flicker: | EN61000-3-3:2008 |

2006/95/EC LVD Directive

- | | |
|---|-------------------------|
| <input checked="" type="checkbox"/> Safety: | EN60950-1:2006+A11:2009 |
|---|-------------------------|

2011/65/EU RoHS Directive

- | | |
|---|--|
| <input checked="" type="checkbox"/> Restriction of use of certain substances in electronic equipment: | This product does not contain any of the restricted substances listed in Annex II, in concentrations and applications banned by the directive. |
|---|--|

CE marking



Signature: Timmy Huang

(stamp)

Date: Apr. 10, 2013

Name: Timmy Huang

DECLARATION OF CONFORMITY

Per FCC Part 2 Section 2.1077(a)



Responsible Party Name: **G.B.T. INC. (U.S.A.)**

Address: **17358 Railroad Street
City of Industry, CA 91748**

Phone/Fax No: **(626) 854-9338/ (626) 854-9326**

hereby declares that the product

Product Name: Motherboard

Model Number: GA-970A-DS3P

Conforms to the following specifications:

FCC Part 15, Subpart B, Section 15.107(a) and Section 15.109 (a), Class B Digital Device

Supplementary Information:

This device complies with part 15 of the FCC Rules. Operation is subject to the following two conditions: (1) This device may not cause harmful and (2) this device must accept any interference received, including that may cause undesired operation.

Representative Person's Name: ERIC LU

Signature: Eric Lu

Date: Apr. 10, 2013

Copyright

© 2013 GIGA-BYTE TECHNOLOGY CO., LTD. All rights reserved.

The trademarks mentioned in this manual are legally registered to their respective owners.

Disclaimer

Information in this manual is protected by copyright laws and is the property of GIGABYTE.

Changes to the specifications and features in this manual may be made by GIGABYTE without prior notice.

No part of this manual may be reproduced, copied, translated, transmitted, or published in any form or by any means without GIGABYTE's prior written permission.

- In order to assist in the use of this product, carefully read the User's Manual.
- For product-related information, check on our website at: <http://www.gigabyte.com>

Identifying Your Motherboard Revision

The revision number on your motherboard looks like this: "REV: X.X." For example, "REV: 1.0" means the revision of the motherboard is 1.0. Check your motherboard revision before updating motherboard BIOS, drivers, or when looking for technical information.

Example:

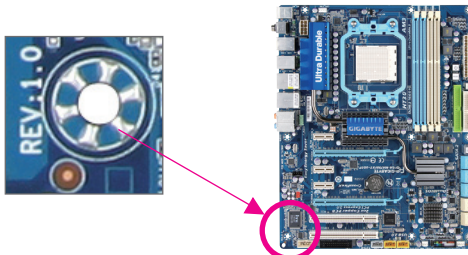
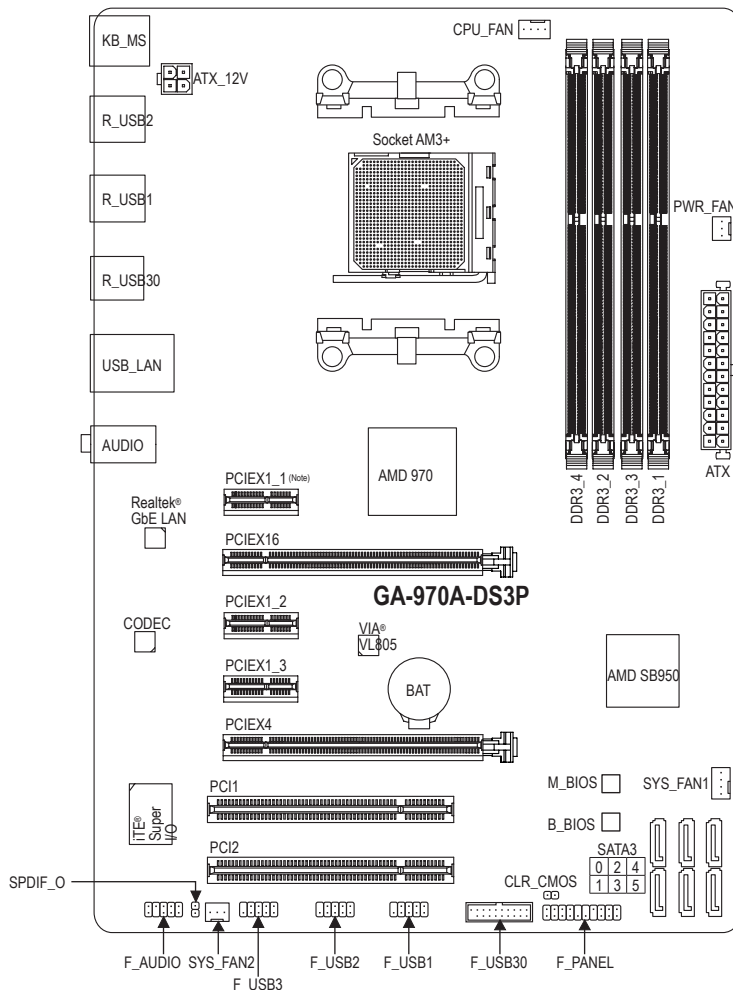

Table of Contents

GA-970A-DS3P Motherboard Layout	4
GA-970A-DS3P Motherboard Block Diagram	5
Chapter 1 Hardware Installation	6
1-1 Installation Precautions	6
1-2 Product Specifications	7
1-3 Installing the CPU	9
1-4 Installing the Memory	9
1-5 Installing an Expansion Card	10
1-6 Back Panel Connectors	10
1-7 Internal Connectors	11
Chapter 2 BIOS Setup	16
2-1 Startup Screen	16
2-2 M.I.T.	17
2-3 System	21
2-4 BIOS Features	22
2-5 Peripherals	24
2-6 Power Management	26
2-7 Save & Exit	27
Chapter 3 Drivers Installation	28
Regulatory Statements	29
Contact Us	32

GA-970A-DS3P Motherboard Layout



(Note) Due to a hardware limitation, the PCIEX1_1 slot can only accommodate a shorter PCI Express x1 expansion card. For a longer expansion card, use other expansion slots.

Box Contents

- GA-970A-DS3P motherboard
- Motherboard driver disk
- User's Manual
- Two SATA cables
- I/O Shield

* The box contents above are for reference only and the actual items shall depend on the product package you obtain.

GA-970A-DS3P Motherboard Block Diagram

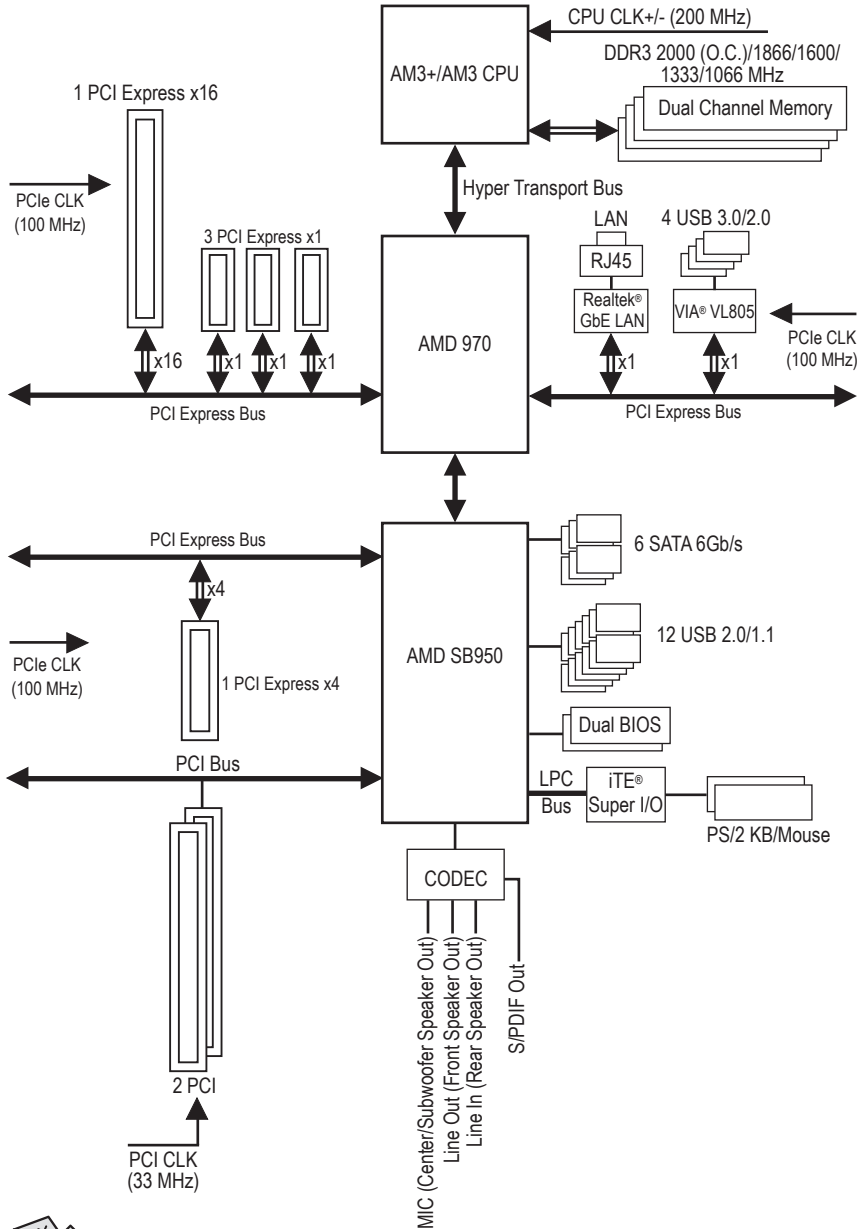

For detailed product information/limitation(s), refer to "1-2 Product Specifications."











Chapter 1 Hardware Installation









1-1 Installation Precautions

The motherboard contains numerous delicate electronic circuits and components which can become damaged as a result of electrostatic discharge (ESD). Prior to installation, carefully read the user's manual and follow these procedures:

- Prior to installation, make sure the chassis is suitable for the motherboard.
- Prior to installation, do not remove or break motherboard S/N (Serial Number) sticker or warranty sticker provided by your dealer. These stickers are required for warranty validation.
- Always remove the AC power by unplugging the power cord from the power outlet before installing or removing the motherboard or other hardware components.
- When connecting hardware components to the internal connectors on the motherboard, make sure they are connected tightly and securely.
- When handling the motherboard, avoid touching any metal leads or connectors.
- It is best to wear an electrostatic discharge (ESD) wrist strap when handling electronic components such as a motherboard, CPU or memory. If you do not have an ESD wrist strap, keep your hands dry and first touch a metal object to eliminate static electricity.
- Prior to installing the motherboard, please have it on top of an antistatic pad or within an electrostatic shielding container.
- Before unplugging the power supply cable from the motherboard, make sure the power supply has been turned off.
- Before turning on the power, make sure the power supply voltage has been set according to the local voltage standard.
- Before using the product, please verify that all cables and power connectors of your hardware components are connected.
- To prevent damage to the motherboard, do not allow screws to come in contact with the motherboard circuit or its components.
- Make sure there are no leftover screws or metal components placed on the motherboard or within the computer casing.
- Do not place the computer system on an uneven surface.
- Do not place the computer system in a high-temperature environment.
- Turning on the computer power during the installation process can lead to damage to system components as well as physical harm to the user.
- If you are uncertain about any installation steps or have a problem related to the use of the product, please consult a certified computer technician.

1-2 Product Specifications

	CPU	<ul style="list-style-type: none"> ◆ AM3+ Socket: <ul style="list-style-type: none"> - AMD AM3+ FX processor - AMD AM3 Phenom™ II processor/ AMD Athlon™ II processor (Go to GIGABYTE's website for the latest CPU support list.)
	Hyper Transport Bus	<ul style="list-style-type: none"> ◆ 4800 MT/s
	Chipset	<ul style="list-style-type: none"> ◆ North Bridge: AMD 970 ◆ South Bridge: AMD SB950
	Memory	<ul style="list-style-type: none"> ◆ 4 x 1.5V DDR3 DIMM sockets supporting up to 32 GB of system memory <ul style="list-style-type: none"> * Due to a Windows 32-bit operating system limitation, when more than 4 GB of physical memory is installed, the actual memory size displayed will be less than the size of the physical memory installed. ◆ Dual channel memory architecture ◆ Support for DDR3 2000(O.C.)/1866/1600/1333/1066 MHz memory modules <ul style="list-style-type: none"> * To support a DDR3 1866 MHz (and above) memory, you must install an AM3+ CPU first. (Go to GIGABYTE's website for the latest supported memory speeds and memory modules.)
	Audio	<ul style="list-style-type: none"> ◆ Realtek® ALC887 audio codec ◆ High Definition Audio ◆ 2/4/5.1/7.1-channel ◆ Support for S/PDIF Out
	LAN	<ul style="list-style-type: none"> ◆ Realtek® GbE LAN chip (10/100/1000 Mbit)
	Expansion Slots	<ul style="list-style-type: none"> ◆ 1 x PCI Express x16 slot, running at x16 (PCIEX16) <ul style="list-style-type: none"> * For optimum performance, if only one PCI Express graphics card is to be installed, be sure to install it in the PCIEX16 slot. ◆ 1 x PCI Express x16 slot, running at x4 (PCIEX4) ◆ 3 x PCI Express x1 slots (All PCI Express slots conform to PCI Express 2.0 standard.) <ul style="list-style-type: none"> ◆ 2 x PCI slots
	Storage Interface	<ul style="list-style-type: none"> ◆ South Bridge: <ul style="list-style-type: none"> - 6 x SATA 6Gb/s connectors supporting up to 6 SATA 6Gb/s devices - Support for RAID 0, RAID 1, RAID 5, RAID 10, and JBOD
	USB	<ul style="list-style-type: none"> ◆ South Bridge: <ul style="list-style-type: none"> - Up to 12 USB 2.0/1.1 ports (6 ports on the back panel, 6 ports available through the internal USB headers) ◆ VIA® VL805 chip: <ul style="list-style-type: none"> - Up to 4 USB 3.0/2.0 ports (2 ports on the back panel, 2 ports available through the internal USB header)
	Internal Connectors	<ul style="list-style-type: none"> ◆ 1 x 24-pin ATX main power connector ◆ 1 x 4-pin ATX 12V power connector ◆ 6 x SATA 6Gb/s connectors ◆ 1 x CPU fan header ◆ 2 x system fan headers ◆ 1 x power fan header ◆ 1 x front panel header

 Internal Connectors	<ul style="list-style-type: none"> ◆ 1 x front panel audio header ◆ 1 x S/PDIF Out header ◆ 1 x USB 3.0/2.0 header ◆ 3 x USB 2.0/1.1 headers ◆ 1 x Clear CMOS jumper
 Back Panel Connectors	<ul style="list-style-type: none"> ◆ 1 x PS/2 keyboard port ◆ 1 x PS/2 mouse port ◆ 2 x USB 3.0/2.0 ports ◆ 6 x USB 2.0/1.1 ports ◆ 1 x RJ-45 port ◆ 3 x audio jacks (Line In/Line Out/Microphone)
 I/O Controller	<ul style="list-style-type: none"> ◆ iTE® I/O Controller Chip
 Hardware Monitor	<ul style="list-style-type: none"> ◆ System voltage detection ◆ CPU/System temperature detection ◆ CPU/System/Power fan speed detection ◆ CPU overheating warning ◆ CPU/System/Power fan fail warning ◆ CPU/System fan speed control <ul style="list-style-type: none"> * Whether the CPU/system fan speed control function is supported will depend on the CPU/system cooler you install.
 BIOS	<ul style="list-style-type: none"> ◆ 2 x 32 Mbit flash ◆ Use of licensed AMI EFI BIOS ◆ Support for DualBIOS™ ◆ PnP 1.0a, DMI 2.0, SM BIOS 2.6, ACPI 2.0a
 Unique Features	<ul style="list-style-type: none"> ◆ Support for @BIOS ◆ Support for Q-Flash ◆ Support for Xpress Install ◆ Support for EasyTune <ul style="list-style-type: none"> * Available functions in EasyTune may differ by motherboard model. ◆ Support for Smart Recovery 2 ◆ Support for Auto Green ◆ Support for ON/OFF Charge ◆ Support for 3TB+ Unlock ◆ Support for Q-Share
 Bundled Software	<ul style="list-style-type: none"> ◆ Norton Internet Security (OEM version)
 Operating System	<ul style="list-style-type: none"> ◆ Support for Windows 8/7/XP
 Form Factor	<ul style="list-style-type: none"> ◆ ATX Form Factor; 30.5cm x 21.5cm

* GIGABYTE reserves the right to make any changes to the product specifications and product-related information without prior notice.

* Please visit the **Support & Downloads\Utility** page on GIGABYTE's website to check the supported operating system(s) for the software listed in the "Unique Features" and "Bundled Software" columns.

1-3 Installing the CPU



Read the following guidelines before you begin to install the CPU:

- Make sure that the motherboard supports the CPU.
(Go to GIGABYTE's website for the latest CPU support list.)
- Always turn off the computer and unplug the power cord from the power outlet before installing the CPU to prevent hardware damage.
- Locate the pin one of the CPU. The CPU cannot be inserted if oriented incorrectly. (Or you may locate the notches on both sides of the CPU and alignment keys on the CPU socket.)
- Apply an even and thin layer of thermal grease on the surface of the CPU.
- Do not turn on the computer if the CPU cooler is not installed, otherwise overheating and damage of the CPU may occur.
- Set the CPU host frequency in accordance with the CPU specifications. It is not recommended that the system bus frequency be set beyond hardware specifications since it does not meet the standard requirements for the peripherals. If you wish to set the frequency beyond the standard specifications, please do so according to your hardware specifications including the CPU, graphics card, memory, hard drive, etc.

Installing the CPU

Locate the pin one (denoted by a small triangle) of the CPU socket and the CPU.

A Small Triangle Marking Denotes Pin One of the Socket

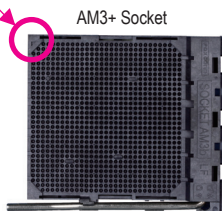

A Small Triangle Marking Denotes CPU Pin One



1-4 Installing the Memory



Read the following guidelines before you begin to install the memory:

- Make sure that the motherboard supports the memory. It is recommended that memory of the same capacity, brand, speed, and chips be used.
(Go to GIGABYTE's website for the latest supported memory speeds and memory modules.)
- Always turn off the computer and unplug the power cord from the power outlet before installing the memory to prevent hardware damage.
- Memory modules have a foolproof design. A memory module can be installed in only one direction. If you are unable to insert the memory, switch the direction.

Dual Channel Memory Configuration

This motherboard provides four DDR3 memory sockets and supports Dual Channel Technology. After the memory is installed, the BIOS will automatically detect the specifications and capacity of the memory. Enabling Dual Channel memory mode will double the original memory bandwidth.

The four DDR3 memory sockets are divided into two channels and each channel has two memory sockets as following:

- ▶▶ Channel A: DDR3_2, DDR3_4
- ▶▶ Channel B: DDR3_1, DDR3_3

Due to CPU limitations, read the following guidelines before installing the memory in Dual Channel mode.

1. Dual Channel mode cannot be enabled if only one DDR3 memory module is installed.
2. When enabling Dual Channel mode with two or four memory modules, it is recommended that memory of the same capacity, brand, speed, and chips be used and installed in the same colored DDR3 sockets for optimum performance. For optimum performance, when enabling Dual Channel mode with two memory modules, we recommend that you install them in the DDR3_1 and DDR3_2 sockets.

1-5 Installing an Expansion Card



Read the following guidelines before you begin to install an expansion card:

- Make sure the motherboard supports the expansion card. Carefully read the manual that came with your expansion card.
- Always turn off the computer and unplug the power cord from the power outlet before installing an expansion card to prevent hardware damage.

1-6 Back Panel Connectors

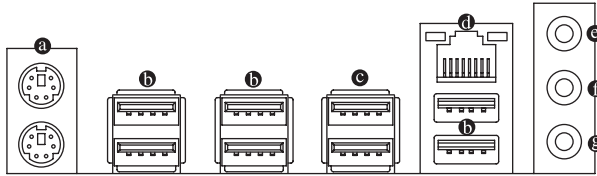

a PS/2 Keyboard/Mouse Port

Use this port to connect a PS/2 mouse or keyboard.

b USB 2.0/1.1 Port

The USB port supports the USB 2.0/1.1 specification. Use this port for USB devices such as a USB keyboard/mouse, USB printer, USB flash drive and etc.

c USB 3.0/2.0 Port

The USB 3.0 port supports the USB 3.0 specification and is compatible to the USB 2.0/1.1 specification. Use this port for USB devices such as a USB keyboard/mouse, USB printer, USB flash drive and etc.

d RJ-45 LAN Port

The Gigabit Ethernet LAN port provides Internet connection at up to 1 Gbps data rate. The following describes the states of the LAN port LEDs.

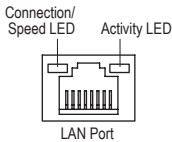

Connection/Speed LED:

State	Description
Orange	1 Gbps data rate
Green	100 Mbps data rate
Off	10 Mbps data rate

Activity LED:

State	Description
Blinking	Data transmission or receiving is occurring
Off	No data transmission or receiving is occurring

e Line In Jack (Blue)

The default line in jack. Use this audio jack for line in devices such as an optical drive, walkman, etc.

f Line Out Jack (Green)

The default line out jack. Use this audio jack for a headphone or 2-channel speaker. This jack can be used to connect front speakers in a 4/5.1/7.1-channel audio configuration.

g Mic In Jack (Pink)

The default Mic in jack. Microphones must be connected to this jack.



To configure 7.1-channel audio, you have to use an HD front panel audio module and enable the multi-channel audio feature through the audio driver.



- When removing the cable connected to a back panel connector, first remove the cable from your device and then remove it from the motherboard.
- When removing the cable, pull it straight out from the connector. Do not rock it side to side to prevent an electrical short inside the cable connector.

1-7 Internal Connectors

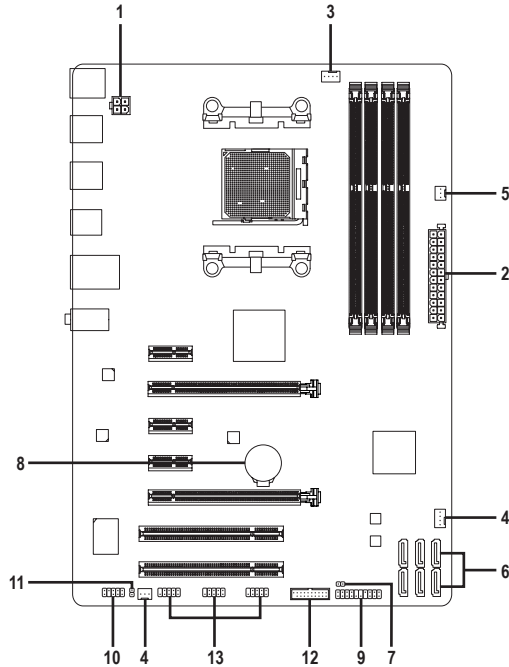

1)	ATX_12V	8)	BAT
2)	ATX	9)	F_PANEL
3)	CPU_FAN	10)	F_AUDIO
4)	SYS_FAN1/SYS_FAN2	11)	SPDIF_O
5)	PWR_FAN	12)	F_USB30
6)	SATA3 0/1/2/3/4/5	13)	F_USB1/F_USB2/F_USB3
7)	CLR_CMOS		



Read the following guidelines before connecting external devices:

- First make sure your devices are compliant with the connectors you wish to connect.
- Before installing the devices, be sure to turn off the devices and your computer. Unplug the power cord from the power outlet to prevent damage to the devices.
- After installing the device and before turning on the computer, make sure the device cable has been securely attached to the connector on the motherboard.

1/2) ATX_12V/ATX (2x2 12V Power Connector and 2x12 Main Power Connector)

With the use of the power connector, the power supply can supply enough stable power to all the components on the motherboard. Before connecting the power connector, first make sure the power supply is turned off and all devices are properly installed. The power connector possesses a foolproof design. Connect the power supply cable to the power connector in the correct orientation.

The 12V power connector mainly supplies power to the CPU. If the 12V power connector is not connected, the computer will not start.



To meet expansion requirements, it is recommended that a power supply that can withstand high power consumption be used (500W or greater). If a power supply is used that does not provide the required power, the result can lead to an unstable or unbootable system.

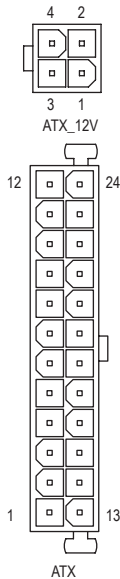

ATX_12V:

Pin No.	Definition
1	GND
2	GND
3	+12V
4	+12V

ATX:

Pin No.	Definition	Pin No.	Definition
1	3.3V	13	3.3V
2	3.3V	14	-12V
3	GND	15	GND
4	+5V	16	PS_ON (soft On/Off)
5	GND	17	GND
6	+5V	18	GND
7	GND	19	GND
8	Power Good	20	-5V
9	5VSB (stand by +5V)	21	+5V
10	+12V	22	+5V
11	+12V (Only for 2x12-pin ATX)	23	+5V (Only for 2x12-pin ATX)
12	3.3V (Only for 2x12-pin ATX)	24	GND (Only for 2x12-pin ATX)

3/4/5) CPU_FAN/SYS_FAN1/SYS_FAN2/PWR_FAN (Fan Headers)

The motherboard has a 4-pin CPU fan header (CPU_FAN), a 4-pin (SYS_FAN1) and a 3-pin (SYS_FAN2) system fan headers, and a 3-pin power fan header (PWR_FAN). Most fan headers possess a foolproof insertion design. When connecting a fan cable, be sure to connect it in the correct orientation (the black connector wire is the ground wire). The speed control function requires the use of a fan with fan speed control design. For optimum heat dissipation, it is recommended that a system fan be installed inside the chassis.

CPU_FAN:

Pin No.	Definition
1	GND
2	+12V
3	Sense
4	Speed Control

SYS_FAN2/PWR_FAN:

Pin No.	Definition
1	GND
2	+12V
3	Sense

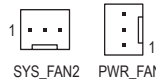

SYS_FAN1:

Pin No.	Definition
1	GND
2	+12V
3	Sense
4	Reserve



- Be sure to connect fan cables to the fan headers to prevent your CPU and system from overheating. Overheating may result in damage to the CPU or the system may hang.
- These fan headers are not configuration jumper blocks. Do not place a jumper cap on the headers.

6) SATA3 0/1/2/3/4/5 (SATA 6Gb/s Connectors)

The SATA connectors conform to SATA 6Gb/s standard and are compatible with SATA 3Gb/s and SATA 1.5Gb/s standard. Each SATA connector supports a single SATA device. The AMD SB950 controller supports RAID 0, RAID 1, RAID 5, RAID 10, and JBOD.

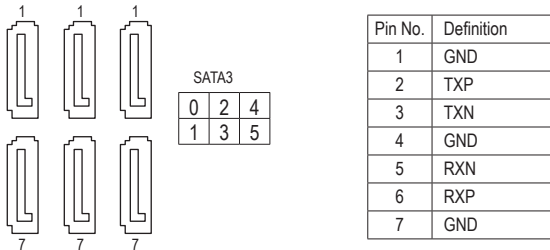

- A RAID 0 or RAID 1 configuration requires at least two hard drives. If more than two hard drives are to be used, the total number of hard drives must be an even number.
- A RAID 5 configuration requires at least three hard drives. (The total number of hard drives does not have to be an even number.)
- A RAID 10 configuration requires four hard drives.

7) CLR_CMOS (Clear CMOS Jumper)

Use this jumper to clear the CMOS values (e.g. date information and BIOS configurations) and reset the CMOS values to factory defaults. To clear the CMOS values, use a metal object like a screwdriver to touch the two pins for a few seconds.



Open: Normal



Short: Clear CMOS Values



- Always turn off your computer and unplug the power cord from the power outlet before clearing the CMOS values.
- After system restart, go to BIOS Setup to load factory defaults (select Load Optimized Defaults) or manually configure the BIOS settings (refer to Chapter 2, "BIOS Setup," for BIOS configurations).

8) BAT (Battery)

The battery provides power to keep the values (such as BIOS configurations, date, and time information) in the CMOS when the computer is turned off. Replace the battery when the battery voltage drops to a low level, or the CMOS values may not be accurate or may be lost.

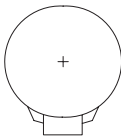

You may clear the CMOS values by removing the battery:

1. Turn off your computer and unplug the power cord.
2. Gently remove the battery from the battery holder and wait for one minute. (Or use a metal object like a screwdriver to touch the positive and negative terminals of the battery holder, making them short for 5 seconds.)
3. Replace the battery.
4. Plug in the power cord and restart your computer.



- Always turn off your computer and unplug the power cord before replacing the battery.
- Replace the battery with an equivalent one. Danger of explosion if the battery is replaced with an incorrect model.
- Contact the place of purchase or local dealer if you are not able to replace the battery by yourself or uncertain about the battery model.
- When installing the battery, note the orientation of the positive side (+) and the negative side (-) of the battery (the positive side should face up).
- Used batteries must be handled in accordance with local environmental regulations.

9) F_PANEL (Front Panel Header)

Connect the power switch, reset switch, speaker, chassis intrusion switch/sensor and system status indicator on the chassis to this header according to the pin assignments below. Note the positive and negative pins before connecting the cables.

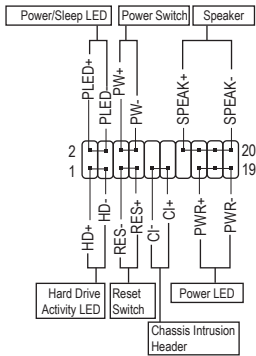

- **PLED/PWR (Power/Sleep LED):**

System Status	LED
S0	On
S1	Blinking
S3/S4/S5	Off

Connects to the power status indicator on the chassis front panel. The LED is on when the system is operating. The LED keeps blinking when the system is in S1 sleep state. The LED is off when the system is in S3/S4 sleep state or powered off (S5).

- **PW (Power Switch):**

Connects to the power switch on the chassis front panel. You may configure the way to turn off your system using the power switch (refer to Chapter 2, "BIOS Setup," "Power Management Setup," for more information).

- **Speaker (Speaker):**

Connects to the speaker on the chassis front panel. The system reports system startup status by issuing a beep code. One single short beep will be heard if no problem is detected at system startup.

- **HD (Hard Drive Activity LED):**

Connects to the hard drive activity LED on the chassis front panel. The LED is on when the hard drive is reading or writing data.

- **RES (Reset Switch):**

Connects to the reset switch on the chassis front panel. Press the reset switch to restart the computer if the computer freezes and fails to perform a normal restart.

- **CI (Chassis Intrusion Header):**

Connects to the chassis intrusion switch/sensor on the chassis that can detect if the chassis cover has been removed. This function requires a chassis with a chassis intrusion switch/sensor.



The front panel design may differ by chassis. A front panel module mainly consists of power switch, reset switch, power LED, hard drive activity LED, speaker and etc. When connecting your chassis front panel module to this header, make sure the wire assignments and the pin assignments are matched correctly.

10) F_AUDIO (Front Panel Audio Header)

The front panel audio header supports Intel High Definition audio (HD) and AC'97 audio. You may connect your chassis front panel audio module to this header. Make sure the wire assignments of the module connector match the pin assignments of the motherboard header. Incorrect connection between the module connector and the motherboard header will make the device unable to work or even damage it.

For HD Front Panel Audio:

For AC'97 Front Panel Audio:



Pin No.	Definition
1	MIC2_L
2	GND
3	MIC2_R
4	-ACZ_DET
5	LINE2_R
6	GND
7	FAUDIO_JD
8	No Pin
9	LINE2_L
10	GND

Pin No.	Definition
1	MIC
2	GND
3	MIC Power
4	NC
5	Line Out (R)
6	NC
7	NC
8	No Pin
9	Line Out (L)
10	NC



- The front panel audio header supports HD audio by default.
- Audio signals will be present on both of the front and back panel audio connections simultaneously.
- Some chassis provide a front panel audio module that has separated connectors on each wire instead of a single plug. For information about connecting the front panel audio module that has different wire assignments, please contact the chassis manufacturer.

11) SPDIF_O (S/PDIF Out Header)

This header supports digital S/PDIF Out and connects a S/PDIF digital audio cable (provided by expansion cards) for digital audio output from your motherboard to certain expansion cards like graphics cards and sound cards. For example, some graphics cards may require you to use a S/PDIF digital audio cable for digital audio output from your motherboard to your graphics card if you wish to connect an HDMI display to the graphics card and have digital audio output from the HDMI display at the same time. For information about connecting the S/PDIF digital audio cable, carefully read the manual for your expansion card.



Pin No.	Definition
1	SPDIFO
2	GND

12) F_USB30 (USB 3.0/2.0 Header)

The header conforms to USB 3.0/2.0 specification and can provide two USB ports. For purchasing the optional 3.5" front panel that provides two USB 3.0/2.0 ports, please contact the local dealer.

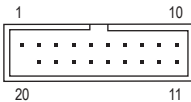

Pin No.	Definition	Pin No.	Definition	Pin No.	Definition
1	VBUS	8	D1-	15	SSTX2-
2	SSRX1-	9	D1+	16	GND
3	SSRX1+	10	NC	17	SSRX2+
4	GND	11	D2+	18	SSRX2-
5	SSTX1-	12	D2-	19	VBUS
6	SSTX1+	13	GND	20	No Pin
7	GND	14	SSTX2+		

13) F_USB1/F_USB2/F_USB3 (USB Headers)

The headers conform to USB 2.0/1.1 specification. Each USB header can provide two USB ports via an optional USB bracket. For purchasing the optional USB bracket, please contact the local dealer.



Pin No.	Definition	Pin No.	Definition
1	Power (5V)	6	USB DY+
2	Power (5V)	7	GND
3	USB DX-	8	GND
4	USB DY-	9	No Pin
5	USB DX+	10	NC



- Do not plug the IEEE 1394 bracket (2x5-pin) cable into the USB header.
- Prior to installing the USB bracket, be sure to turn off your computer and unplug the power cord from the power outlet to prevent damage to the USB bracket.

Chapter 2 BIOS Setup

BIOS (Basic Input and Output System) records hardware parameters of the system in the CMOS on the motherboard. Its major functions include conducting the Power-On Self-Test (POST) during system startup, saving system parameters and loading operating system, etc. BIOS includes a BIOS Setup program that allows the user to modify basic system configuration settings or to activate certain system features.

When the power is turned off, the battery on the motherboard supplies the necessary power to the CMOS to keep the configuration values in the CMOS.

To access the BIOS Setup program, press the <Delete> key during the POST when the power is turned on.

To upgrade the BIOS, use either the GIGABYTE Q-Flash or @BIOS utility.

- Q-Flash allows the user to quickly and easily upgrade or back up BIOS without entering the operating system.
- @BIOS is a Windows-based utility that searches and downloads the latest version of BIOS from the Internet and updates the BIOS.



- Because BIOS flashing is potentially risky, if you do not encounter problems using the current version of BIOS, it is recommended that you not flash the BIOS. To flash the BIOS, do it with caution. Inadequate BIOS flashing may result in system malfunction.
- It is recommended that you not alter the default settings (unless you need to) to prevent system instability or other unexpected results. Inadequately altering the settings may result in system's failure to boot. If this occurs, try to clear the CMOS values and reset the board to default values. (Refer to the "Load Optimized Defaults" section in this chapter or introductions of the battery/clear CMOS jumper in Chapter 1 for how to clear the CMOS values.)

2-1 Startup Screen

The following startup Logo screen will appear when the computer boots.

(Sample BIOS Version: E4)



On the main menu of the BIOS Setup program, press arrow keys to move among the items and press <Enter> to accept or enter a sub-menu. Or you can use your mouse to select the item you want.



- When the system is not stable as usual, select the **Load Optimized Defaults** item to set your system to its defaults.
- The BIOS Setup menus described in this chapter are for reference only and may differ by BIOS version.

2-2 M.I.T.



This section provides information on the BIOS version, CPU base clock, CPU frequency, memory frequency, total memory size, CPU temperature, Vcore, and memory voltage.



Whether the system will work stably with the overclock/overvoltage settings you made is dependent on your overall system configurations. Incorrectly doing overclock/overvoltage may result in damage to CPU, chipset, or memory and reduce the useful life of these components. This page is for advanced users only and we recommend you not to alter the default settings to prevent system instability or other unexpected results. (Inadequately altering the settings may result in system's failure to boot. If this occurs, clear the CMOS values and reset the board to default values.)

▶ M.I.T. Current Status

This screen provides information on CPU/memory frequencies/parameters.

▶ Advanced Frequency Settings

⊖ BCLK Clock Control

Allows you to manually set the CPU base clock in 1 MHz increments. (Default: Auto)

Important: It is highly recommended that the CPU frequency be set in accordance with the CPU specifications.

⊖ CPU NorthBridge Frequency

Allows you to alter the North Bridge controller frequency for the installed CPU. (Default: Auto)

⊖ HT Link Frequency

Allows you to manually set the frequency for the HT Link between the CPU and chipset. (Default: Auto)

⊖ CPU Clock Ratio

Allows you to alter the clock ratio for the installed CPU. The adjustable range is dependent on the CPU being installed.

⊖ CPU Frequency

Displays the current operating CPU frequency.

▶ Advanced CPU Core Features

⊖ CPU Clock Ratio, CPU Frequency

The settings above are synchronous to those under the same items on the **Advanced Frequency Settings** menu.

- ☞ **Core Performance Boost** ^(Note 1)
 Allows you to determine whether to enable the Core Performance Boost (CPB) technology, a CPU performance-boost technology. (Default: Auto)
- ☞ **CPB Ratio** ^(Note 1)
 Allows you alter the ratio for the CPB. The adjustable range is dependent on the CPU being installed. (Default: Auto)
- ☞ **CPU Unlock**
 Allows you to determine whether unlock hidden CPU cores. (Default: Disabled)
- ☞ **Cool&Quiet**

 - ▶▶ Enabled Lets the AMD Cool'n'Quiet driver dynamically adjust the CPU clock and VID to reduce heat output from your computer and its power consumption. (Default)
 - ▶▶ Disabled Disables this function.
- ☞ **C1E Support**
 Enables or disables the C1E CPU power-saving function in system halt state. When enabled, the power consumption will be reduced during system halt state.

 - ▶▶ Enabled If a CPU that supports hardware C1E is installed, the BIOS will automatically enable the hardware C1E function. If not, the BIOS will enable the software C1E function. (Default)
 - ▶▶ Disabled Disables this function.
- ☞ **SVM**
 Virtualization enhanced by Virtualization Technology will allow a platform to run multiple operating systems and applications in independent partitions. With virtualization, one computer system can function as multiple virtual systems. (Default: Enabled)
- ☞ **CPU core Control** ^(Note 1)
 Allows you to determine whether to manually enable/disable CPU cores. **Automatic mode** allows the BIOS to enable all CPU cores (number of cores available depends on the CPU being used). (Default: Automatic mode)
- ☞ **Extreme Memory Profile (X.M.P.)** ^(Note 2)
 Allows the BIOS to read the SPD data on XMP memory module(s) to enhance memory performance when enabled.

 - ▶▶ Disabled Disables this function. (Default)
 - ▶▶ Profile1 Uses Profile 1 settings.
 - ▶▶ Profile2 ^(Note 2) Uses Profile 2 settings.
- ☞ **System Memory Multiplier**
 Allows you to set the system memory multiplier. **Auto** sets memory multiplier according to memory SPD data. (Default: Auto)
- ☞ **Memory Frequency (MHz)**
 The first memory frequency value is the normal operating frequency of the memory being used; the second is the memory frequency that is automatically adjusted according to the **System Memory Multiplier** settings.

(Note 1) This item is present only when you install a CPU that supports this feature.

(Note 2) This item is present only when you install a CPU and a memory module that support this feature.

▶ **Advanced Memory Settings**

☞ **Extreme Memory Profile (X.M.P.)** ^(Note), **System Memory Multiplier**, **Memory Frequency(MHz)**
The settings above are synchronous to those under the same items on the **Advanced Frequency Settings** menu.

☞ **DRAM Timing Selectable**

Quick and **Expert** allows the **Channel Interleaving**, **Rank Interleaving**, and memory timing settings below to be configurable. Options are: Auto (default), Quick, Expert.

☞ **Profile DDR Voltage**

When using a non-XMP memory module or **Extreme Memory Profile (X.M.P.)** is set to **Disabled**, this item will display as **1.50V**. When **Extreme Memory Profile (X.M.P.)** is set to **Profile1** or **Profile2**, this item will display the value based on the SPD data on the XMP memory.

☞ **Profile VTT Voltage**

The value displayed here is dependent on the CPU being used.

☞ **Channel Interleaving**

Enables or disables memory channel interleaving. **Enabled** allows the system to simultaneously access different channels of the memory to increase memory performance and stability. **Auto** lets the BIOS automatically configure this setting. (Default: Auto)

☞ **Rank Interleaving**

Enables or disables memory rank interleaving. **Enabled** allows the system to simultaneously access different ranks of the memory to increase memory performance and stability. **Auto** lets the BIOS automatically configure this setting. (Default: Auto)

▶ **Channel A/B Timing Settings**

This sub-menu provides memory timing settings for each channel of memory. The respective timing setting screens are configurable only when **DRAM Timing Selectable** is set to **Quick** or **Expert**. Note: Your system may become unstable or fail to boot after you make changes on the memory timings. If this occurs, please reset the board to default values by loading optimized defaults or clearing the CMOS values.

▶ **Advanced Voltage Settings**

This sub-menu allows you to set CPU and memory voltages.

▶ **PC Health Status**

☞ **Reset Case Open Status**

- ▶▶ Disabled Keeps or clears the record of previous chassis intrusion status. (Default)
- ▶▶ Enabled Clears the record of previous chassis intrusion status and the **Case Open** field will show "No" at next boot.

☞ **Case Open**

Displays the detection status of the chassis intrusion detection device attached to the motherboard CI header. If the system chassis cover is removed, this field will show "Yes", otherwise it will show "No". To clear the chassis intrusion status record, set **Reset Case Open Status** to **Enabled**, save the settings to the CMOS, and then restart your system.

☞ **CPU Vcore/Dram Voltage/+3.3V/+5V/+12V**

Displays the current system voltages.

☞ **CPU/System Temperature**

Displays current CPU/system temperature.

(Note) This item is present only when you install a CPU and a memory module that support this feature.

- ☞ **CPU/System/Power Fan Speed**
Displays current CPU/system/power fan speed.
- ☞ **CPU Warning Temperature**
Sets the warning threshold for CPU temperature. When CPU temperature exceeds the threshold, BIOS will emit warning sound. Options are: Disabled (default), 60°C/140°F, 70°C/158°F, 80°C/176°F, 90°C/194°F.
- ☞ **CPU/System/Power Fan Fail Warning**
Allows the system to emit warning sound if the fan is not connected or fails. Check the fan condition or fan connection when this occurs. (Default: Disabled)
- ☞ **CPU Fan Speed Control**
Allows you to determine whether to enable the CPU fan speed control function and adjust the fan speed.
 - ▶▶ Normal Allows the CPU fan to run at different speeds according to the CPU temperature. You can adjust the fan speed with EasyTune based on your system requirements. (Default)
 - ▶▶ Silent Allows the CPU fan to run at slow speeds.
 - ▶▶ Manual Allows you to control the CPU fan speed under the **Slope PWM** item.
 - ▶▶ Disabled Allows the CPU fan to run at full speeds.
- ☞ **Slope PWM**
Allows you to control the CPU fan speed. This item is configurable only when **CPU Fan Speed Control** is set to **Manual**. Options are: 0.75 PWM value /°C ~ 2.50 PWM value /°C.
- ☞ **1st/2nd System Fan Speed Control**
Allows you to determine whether to enable the system fan speed control function and adjust the fan speed.
 - ▶▶ Normal Allows the system fan to run at different speeds according to the system temperature. You can adjust the fan speed with EasyTune based on your system requirements. (Default)
 - ▶▶ Silent Allows the system fan to run at slow speeds.
 - ▶▶ Manual Allows you to control the system fan speed under the **Slope PWM** item.
 - ▶▶ Disabled Allows the system fan to run at full speeds.
- ☞ **Slope PWM**
Allows you to control the system fan speed. This item is configurable only when **1st/2nd System Fan Speed Control** is set to **Manual**. Options are: 0.75 PWM value /°C ~ 2.50 PWM value /°C.

2-3 System



This section provides information on your motherboard model and BIOS version. You can also select the default language used by the BIOS and manually set the system time.

System Language

Selects the default language used by the BIOS.

System Date

Sets the system date. The date format is week (read-only), month, date, and year. Use <Enter> to switch between the Month, Date, and Year fields and use the <Page Up> or <Page Down> key to set the desired value.

System Time

Sets the system time. The time format is hour, minute, and second. For example, 1 p.m. is 13:0:0. Use <Enter> to switch between the Hour, Minute, and Second fields and use the <Page Up> or <Page Down> key to set the desired value.

Access Level

Displays the current access level depending on the type of password protection used. (If no password is set, the default will display as Administrator.) The Administrator level allows you to make changes to all BIOS settings; the User level only allows you to make changes to certain BIOS settings but not all.

ATA Port Information

This section provides information on the device connected to each SATA port controlled by Chipset.

2-4 BIOS Features

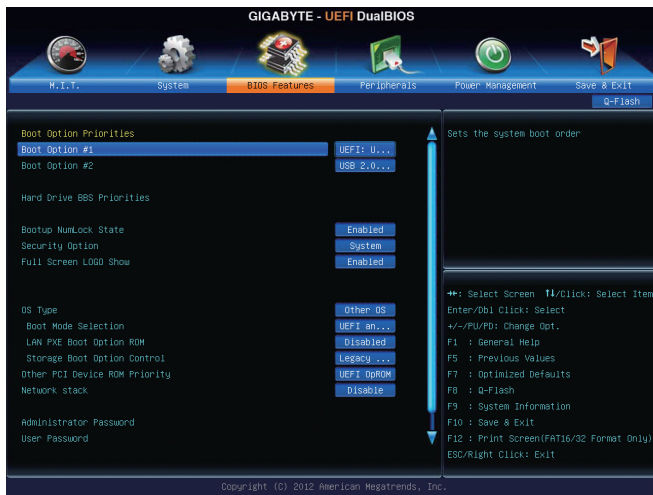

☞ **Boot Option Priorities**

Specifies the overall boot order from the available devices. For example, you can set hard drive as the first priority (**Boot Option #1**) and DVD ROM drive as the second priority (**Boot Option #2**). The list only displays the device with the highest priority for a specific type. For example, only hard drive defined as the first priority on the **Hard Drive BBS Priorities** submenu will be presented here.

Removable storage devices that support GPT format will be prefixed with "UEFI:" string on the boot device list. To boot from an operating system that supports GPT partitioning, select the device prefixed with "UEFI:" string. Or if you want to install an operating system that supports GPT partitioning such as Windows 7 64-bit, select the optical drive that contains the Windows 7 64-bit installation disk and is prefixed with "UEFI:" string.

☞ **Hard Drive/CD/DVD ROM Drive/Floppy Drive/Network Device BBS Priorities**

Specifies the boot order for a specific device type, such as hard drives, optical drives, floppy disk drives, and devices that support Boot from LAN function, etc. Press <Enter> on this item to enter the submenu that presents the devices of the same type that are connected. This item is present only if at least one device for this type is installed.

☞ **Bootup NumLock State**

Enables or disables Numlock feature on the numeric keypad of the keyboard after the POST. (Default: Enabled)

☞ **Security Option**

Specifies whether a password is required every time the system boots, or only when you enter BIOS Setup. After configuring this item, set the password(s) under the **Administrator Password/User Password** item.

- ▶▶ Setup A password is only required for entering the BIOS Setup program.
- ▶▶ System A password is required for booting the system and for entering the BIOS Setup program. (Default)

☞ **Full Screen LOGO Show**

Allows you to determine whether to display the GIGABYTE Logo at system startup. **Disabled** skips the GIGABYTE Logo when the system starts up. (Default: Enabled)

☞ **OS Type**

Allows you to select the operating system to be installed. Set this item to **Windows 8** for Windows 8 operating system. (Default: Other OS)

(Note) This item is present only when you install a CPU that supports this feature.

☞ **CSM Support**

Enables or disables UEFI CSM (Compatibility Support Module) to support a legacy PC boot process.

- ▶▶ Always Enables UEFI CSM. (Default)
- ▶▶ Never Disables UEFI CSM and supports UEFI BIOS boot process only.

This item is configurable only when **OS Type** is set to **Windows 8** or **Windows 8 WHQL**.

☞ **Boot Mode Selection**

Allows you to select which type of operating system to boot.

- ▶▶ UEFI and Legacy Allows booting from operating systems that support legacy option ROM or UEFI option ROM. (Default)
- ▶▶ Legacy Only Allows booting from operating systems that only support legacy Option ROM.
- ▶▶ UEFI Only Allows booting from operating systems that only support UEFI Option ROM.

This item is configurable only when **CSM Support** is set to **Always**.

☞ **LAN PXE Boot Option ROM**

Allows you to select whether to enable the legacy option ROM for the LAN controller. (Default: Disabled)

This item is configurable only when **CSM Support** is set to **Always**.

☞ **Storage Boot Option Control**

Allows you to select whether to enable the UEFI or legacy option ROM for the storage device controller.

- ▶▶ Disabled Disables option ROM.
- ▶▶ Legacy Only Enables legacy option ROM only. (Default)
- ▶▶ UEFI Only Enables UEFI option ROM only.
- ▶▶ Legacy First Enables legacy option ROM first.
- ▶▶ UEFI First Enables UEFI option ROM first.

This item is configurable only when **CSM Support** is set to **Always**.

☞ **Other PCI Device ROM Priority**

Allows you to select whether to enable the UEFI or Legacy option ROM for the PCI device controller other than the LAN, storage device, and graphics controllers.

- ▶▶ Legacy OpROM Enables legacy option ROM only.
- ▶▶ UEFI OpROM Enables UEFI option ROM only. (Default)

☞ **Network stack**

Disables or enables booting from the network to install a GPT format OS, such as installing the OS from the Windows Deployment Services server. (Default: Disable)

☞ **Ipv4 PXE Support**

Enables or disables Ipv4 PXE Support. This item is configurable only when **Network stack** is enabled.

☞ **Ipv6 PXE Support**

Enables or disables Ipv6 PXE Support. This item is configurable only when **Network stack** is enabled.

☞ **Administrator Password**

Allows you to configure an administrator password. Press <Enter> on this item, type the password, and then press <Enter>. You will be requested to confirm the password. Type the password again and press <Enter>. You must enter the administrator password (or user password) at system startup and when entering BIOS Setup. Differing from the user password, the administrator password allows you to make changes to all BIOS settings.

☞ **User Password**

Allows you to configure a user password. Press <Enter> on this item, type the password, and then press <Enter>. You will be requested to confirm the password. Type the password again and press <Enter>.

You must enter the administrator password (or user password) at system startup and when entering BIOS Setup. However, the user password only allows you to make changes to certain BIOS settings but not all.

To cancel the password, press <Enter> on the password item and when requested for the password, enter the correct one first. When prompted for a new password, press <Enter> without entering any password. Press <Enter> again when prompted to confirm.

(Note) This item is present only when you install a CPU that supports this feature.

2-5 Peripherals



- **OnChip SATA Controller**
Enables or disables the integrated SATA controllers. (Default: Enabled)
- **OnChip SATA Type**
Enables or disables RAID for the SATA controllers integrated in the AMD Chipset or configures the SATA controllers to AHCI mode.
 - Native IDE Configures the SATA controller to IDE mode. (Default)
 - RAID Enables RAID for the SATA controller.
 - AHCI Configures the SATA controllers to AHCI mode. Advanced Host Controller Interface (AHCI) is an interface specification that allows the storage driver to enable advanced Serial ATA features such as Native Command Queuing and hot plug.
- **OnChip SATA Port4/5 Type (SATA3 4/SATA3 5 connectors)**
This option is configurable only when OnChip SATA Type is set to RAID or AHCI. Configures the operating mode of the integrated SATA3 4~SATA3 5 and eSATA connectors.
 - IDE Disables RAID for the SATA controller and configures the SATA controller to IDE mode. (Default)
 - As SATA Type The mode depends on the OnChip SATA Type settings.
- **HD Audio Azalia Device**
Enables or disables the onboard audio function. (Default: Enabled)
If you wish to install a 3rd party add-in audio card instead of using the onboard audio, set this item to **Disabled**.
- **Onboard USB Device**
Enables or disables the integrated USB controller. (Default: Enabled)
- **R_USB3.0 Controller (VIA® VL805 USB Controller)**
Enables or disables the VIA® VL805 USB controller. (Default: Enabled)
- **Onboard LAN Controller**
Enables or disables the onboard LAN function. (Default: Enabled)
If you wish to install a 3rd party add-in network card instead of using the onboard LAN, set this item to **Disabled**.

☞ **Legacy USB Support**

Allows USB keyboard/mouse to be used in MS-DOS. (Default: Enabled)

☞ **XHCI Hand-off**

Determines whether to enable XHCI Hand-off feature for an operating system without XHCI Hand-off support. (Default: Enabled)

☞ **EHCI Hand-off**

Determines whether to enable EHCI Hand-off feature for an operating system without EHCI Hand-off support. (Default: Disabled)

☞ **Port 60/64 Emulation**

Enables or disables emulation of I/O ports 64h and 60h. This should be enabled for full legacy support for USB keyboards/mice in MS-DOS or in operating system that does not natively support USB devices. (Default: Disabled)

☞ **USB Storage Devices**

Displays a list of connected USB mass storage devices. This item appears only when a USB storage device is installed.

☞ **IOMMU Controller**

Enables or disables AMD IOMMU support. (Default: Disabled)

▶ **SB SATA Configuration**

☞ **PORT0 Hot Plug~PORT5 Hot Plug**

Enables or disable the hot plug capability for each SATA port. (Default: Disabled)

☞ **SATA Power on PORT0~SATA Power on PORT5**

Enables or disables each SATA port. (Default: Enabled)

2-6 Power Management



☞ Resume by Alarm

Determines whether to power on the system at a desired time. (Default: Disabled)

If enabled, set the date and time as following:

▶▶ Wake up day: Turn on the system at a specific time on each day or on a specific day in a month.

▶▶ Wake up hour/minute/second: Set the time at which the system will be powered on automatically.

Note: When using this function, avoid inadequate shutdown from the operating system or removal of the AC power, or the settings may not be effective.

☞ HPET Support (Note)

Enables or disables High Precision Event Timer (HPET) for Windows 8/7 operating system. (Default: Enabled)

☞ Soft-Off by PWR-BTNN

Configures the way to turn off the computer in MS-DOS mode using the power button.

▶▶ Instant-Off Press the power button and then the system will be turned off instantly. (Default)

▶▶ Delay 4 Sec Press and hold the power button for 4 seconds to turn off the system. If the power button is pressed for less than 4 seconds, the system will enter suspend mode.

☞ AC BACK

Determines the state of the system after the return of power from an AC power loss.

▶▶ Memory The system returns to its last known awake state upon the return of the AC power.

▶▶ Always On The system is turned on upon the return of the AC power.

▶▶ Always Off The system stays off upon the return of the AC power. (Default)

☞ Power On By Keyboard

Allows the system to be turned on by a PS/2 keyboard wake-up event.

Note: To use this function, you need an ATX power supply providing at least 1A on the +5VSB lead.

▶▶ Disabled Disables this function. (Default)

▶▶ Password Set a password with 1~5 characters to turn on the system.

▶▶ Keyboard 98 Press POWER button on the Windows 98 keyboard to turn on the system.

▶▶ Any Key Press any key to turn on the system.

(Note) Supported on Windows 8/7 operating system only.

Power On Password

Set the password when **Power On By Keyboard** is set to **Password**.

Press <Enter> on this item and set a password with up to 5 characters and then press <Enter> to accept. To turn on the system, enter the password and press <Enter>.

Note: To cancel the password, press <Enter> on this item. When prompted for the password, press <Enter> again without entering the password to clear the password settings.

Power On By Mouse

Allows the system to be turned on by a PS/2 mouse wake-up event.

Note: To use this function, you need an ATX power supply providing at least 1A on the +5VSB lead.

- ▶ Disabled Disables this function. (Default)
- ▶ Move Move the mouse to turn on the system.
- ▶ Double Click Double click on left button on the mouse to turn on the system.

ErP

Determines whether to let the system consume least power in S5 (shutdown) state. (Default: Disabled)

Note: When this item is set to **Enabled**, the following functions will become unavailable: PME event wake up, power on by mouse, power on by keyboard, and wake on LAN.

2-7 Save & Exit



Save & Exit Setup

Press <Enter> on this item and select **Yes**. This saves the changes to the CMOS and exits the BIOS Setup program. Select **No** or press <Esc> to return to the BIOS Setup Main Menu.

Exit Without Saving

Press <Enter> on this item and select **Yes**. This exits the BIOS Setup without saving the changes made in BIOS Setup to the CMOS. Select **No** or press <Esc> to return to the BIOS Setup Main Menu.

Load Optimized Defaults

Press <Enter> on this item and select **Yes** to load the optimal BIOS default settings. The BIOS default settings help the system to operate in optimum state. Always load the Optimized defaults after updating the BIOS or after clearing the CMOS values.

☞ **Boot Override**

Allows you to select a device to boot immediately. Press <Enter> on the device you select and select **Yes** to confirm. Your system will restart automatically and boot from that device.

☞ **Save Profiles**

This function allows you to save the current BIOS settings to a profile. You can create up to 8 profiles and save as Setup Profile 1~ Setup Profile 8. Press <Enter> to complete. Or you can select **Select File in HDD/USB/FDD** to save the profile to your storage device.

☞ **Load Profiles**

If your system becomes unstable and you have loaded the BIOS default settings, you can use this function to load the BIOS settings from a profile created before, without the hassles of reconfiguring the BIOS settings. First select the profile you wish to load and then press <Enter> to complete. You can select **Select File in HDD/USB/FDD** to input the profile previously created from your storage device or load the profile automatically created by the BIOS, such as reverting the BIOS settings to the last settings that worked properly (last known good record).

Chapter 3 Drivers Installation



- Before installing the drivers, first install the operating system.
- After installing the operating system, insert the motherboard driver disk into your optical drive. The driver Autorun screen is automatically displayed which looks like that shown in the screen shot below. (If the driver Autorun screen does not appear automatically, go to My Computer, double-click the optical drive and execute the **Run.exe** program.)

After inserting the driver disk, "Xpress Install" will automatically scan your system and then list all the drivers that are recommended to install. You can click the **Install All** button and "Xpress Install" will install all the recommended drivers. Or click **Install Single** Items to manually select the drivers you wish to install.

Regulatory Statements

Regulatory Notices

This document must not be copied without our written permission, and the contents there of must not be imparted to a third party nor be used for any unauthorized purpose.

Contravention will be prosecuted. We believe that the information contained herein was accurate in all respects at the time of printing. GIGABYTE cannot, however, assume any responsibility for errors or omissions in this text. Also note that the information in this document is subject to change without notice and should not be construed as a commitment by GIGABYTE.

Our Commitment to Preserving the Environment

In addition to high-efficiency performance, all GIGABYTE motherboards fulfill European Union regulations for RoHS (Restriction of Certain Hazardous Substances in Electrical and Electronic Equipment) and WEEE (Waste Electrical and Electronic Equipment) environmental directives, as well as most major worldwide safety requirements. To prevent releases of harmful substances into the environment and to maximize the use of our natural resources, GIGABYTE provides the following information on how you can responsibly recycle or reuse most of the materials in your "end of life" product.

Restriction of Hazardous Substances (RoHS) Directive Statement

GIGABYTE products have not intended to add and safe from hazardous substances (Cd, Pb, Hg, Cr+6, PBDE and PBB). The parts and components have been carefully selected to meet RoHS requirement. Moreover, we at GIGABYTE are continuing our efforts to develop products that do not use internationally banned toxic chemicals.

Waste Electrical & Electronic Equipment (WEEE) Directive Statement

GIGABYTE will fulfill the national laws as interpreted from the 2002/96/EC WEEE (Waste Electrical and Electronic Equipment) directive. The WEEE Directive specifies the treatment, collection, recycling and disposal of electric and electronic devices and their components. Under the Directive, used equipment must be marked, collected separately, and disposed of properly.

WEEE Symbol Statement



The symbol shown below is on the product or on its packaging, which indicates that this product must not be disposed of with other waste. Instead, the device should be taken to the waste collection centers for activation of the treatment, collection, recycling and disposal procedure. The separate collection and recycling of your waste equipment at the time of disposal will help to conserve natural resources and ensure that it is recycled in a manner that protects human health and the environment.

For more information about where you can drop off your waste equipment for recycling, please contact your local government office, your household waste disposal service or where you purchased the product for details of environmentally safe recycling.

- When your electrical or electronic equipment is no longer useful to you, "take it back" to your local or regional waste collection administration for recycling.
- If you need further assistance in recycling, reusing in your "end of life" product, you may contact us at the Customer Care number listed in your product's user's manual and we will be glad to help you with your effort.

Finally, we suggest that you practice other environmentally friendly actions by understanding and using the energy-saving features of this product (where applicable), recycling the inner and outer packaging (including shipping containers) this product was delivered in, and by disposing of or recycling used batteries properly. With your help, we can reduce the amount of natural resources needed to produce electrical and electronic equipment, minimize the use of landfills for the disposal of "end of life" products, and generally improve our quality of life by ensuring that potentially hazardous substances are not released into the environment and are disposed of properly.



Contact Us

GIGA-BYTE TECHNOLOGY CO., LTD.

Address: No.6, Bao Chiang Road, Hsin-Tien Dist., New Taipei City 231, Taiwan

TEL: +886-2-8912-4000, FAX: +886-2-8912-4003

Tech. and Non-Tech. Support (Sales/Marketing) : <http://ggts.gigabyte.com.tw>

WEB address (English): <http://www.gigabyte.com>

WEB address (Chinese): <http://www.gigabyte.tw>

You may go to the GIGABYTE website, select your language in the language list on the top right corner of the website.

- **GIGABYTE Global Service System**

A screenshot of the GIGABYTE Global Service System login page. The page has a blue background with a globe icon and the GIGABYTE logo. The text reads: "Welcome to GIGABYTE Service system. If you are a GIGABYTE Passport member, please login with your membership E-Mail address and password. Otherwise, you can simply enter E-Mail address to login." Below this is a form with fields for "Your Email:" and "Your Password:". There is a "Forgot password" link next to the password field. At the bottom, there are buttons for language selection: English, 繁體中文, Deutsch, 简体中文, Français, Polski, and Español.

To submit a technical or non-technical (Sales/Marketing) question, please link to:

<http://ggts.gigabyte.com.tw>

Then select your language to enter the system.